

# Oblicza dTugość

Seminarium OMJ, wrzesień 2023

Dominika Regiec-Cieszyńska

Co może się przydać?

① Rachunki na kątach,  
Δ równoramienne



① Twierdzenie Pitagorasa

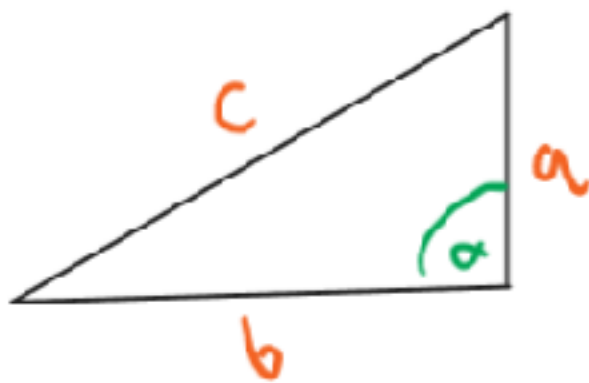

$$\alpha = 90^\circ \Rightarrow a^2 + b^2 = c^2$$

② Trójkąty charakterystyczne

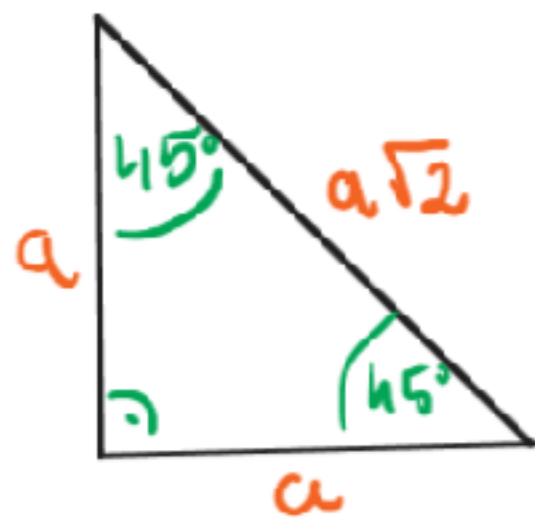

③ Cechy przystawiania trójkątów

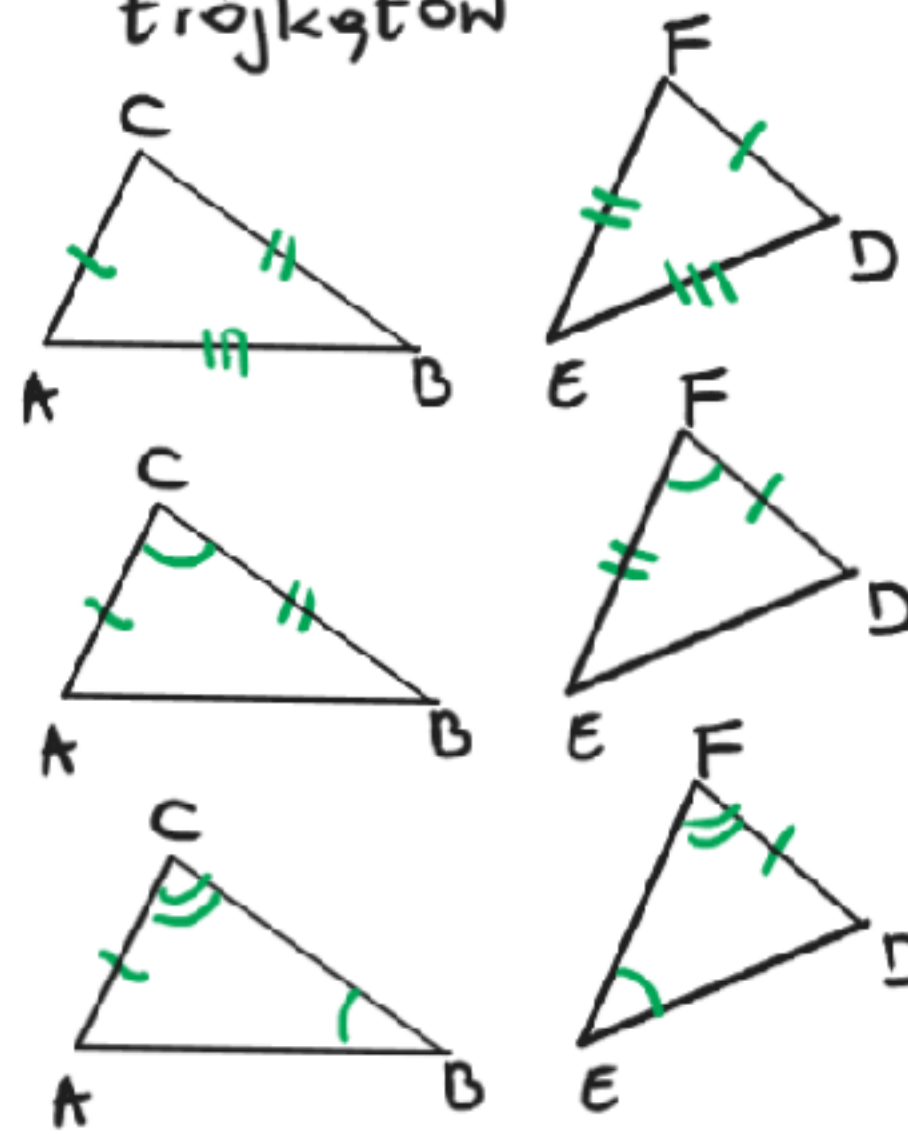

$$\Rightarrow \Delta ABC \cong \Delta DEF$$

Uwaga. Jeśli nie zaznaczono inaczej, narysowane  $\Delta$   
są równoboczne,  $\square$  to kwadraty,  $\bigcirc$  - półkole...

①

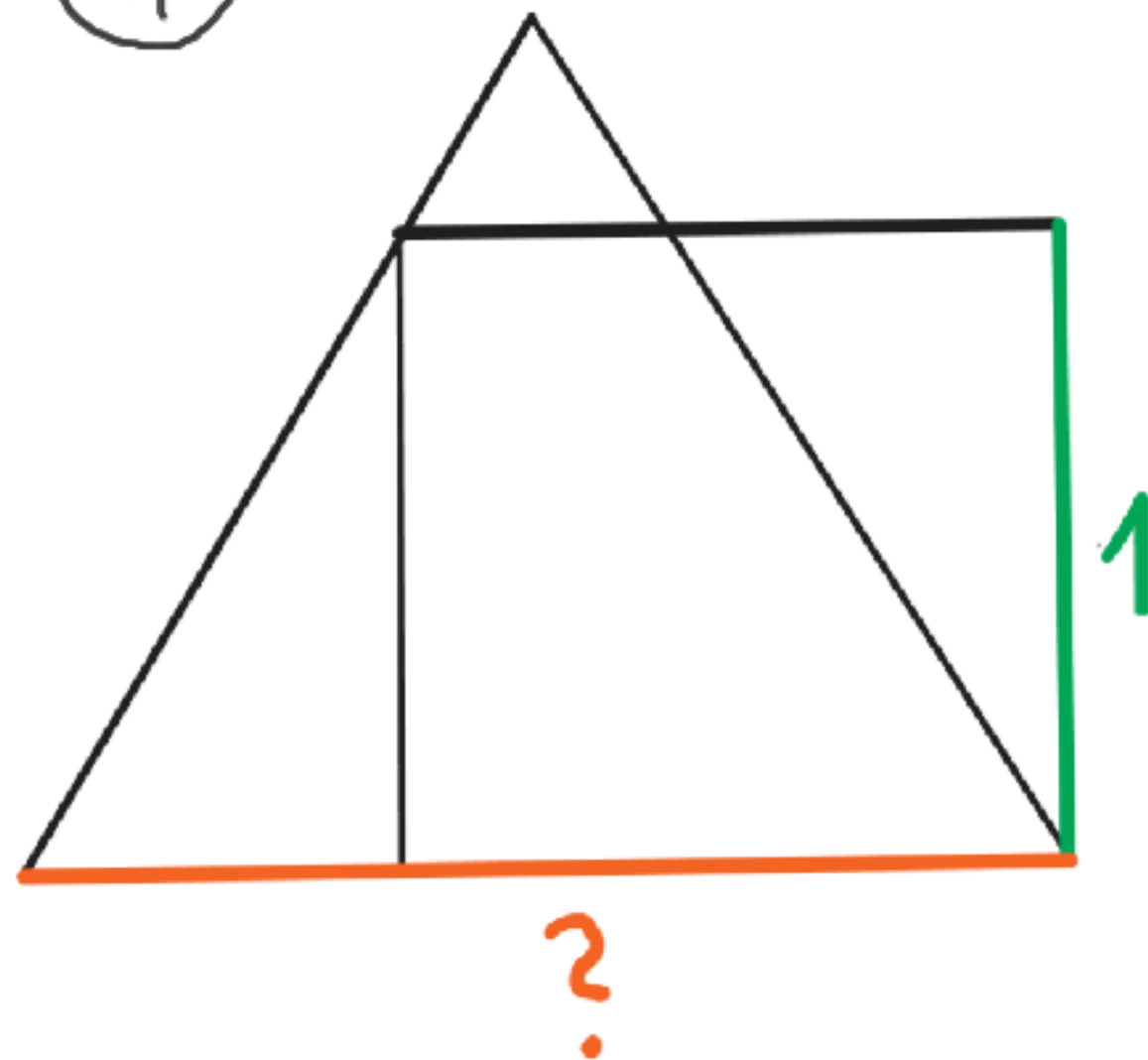

②

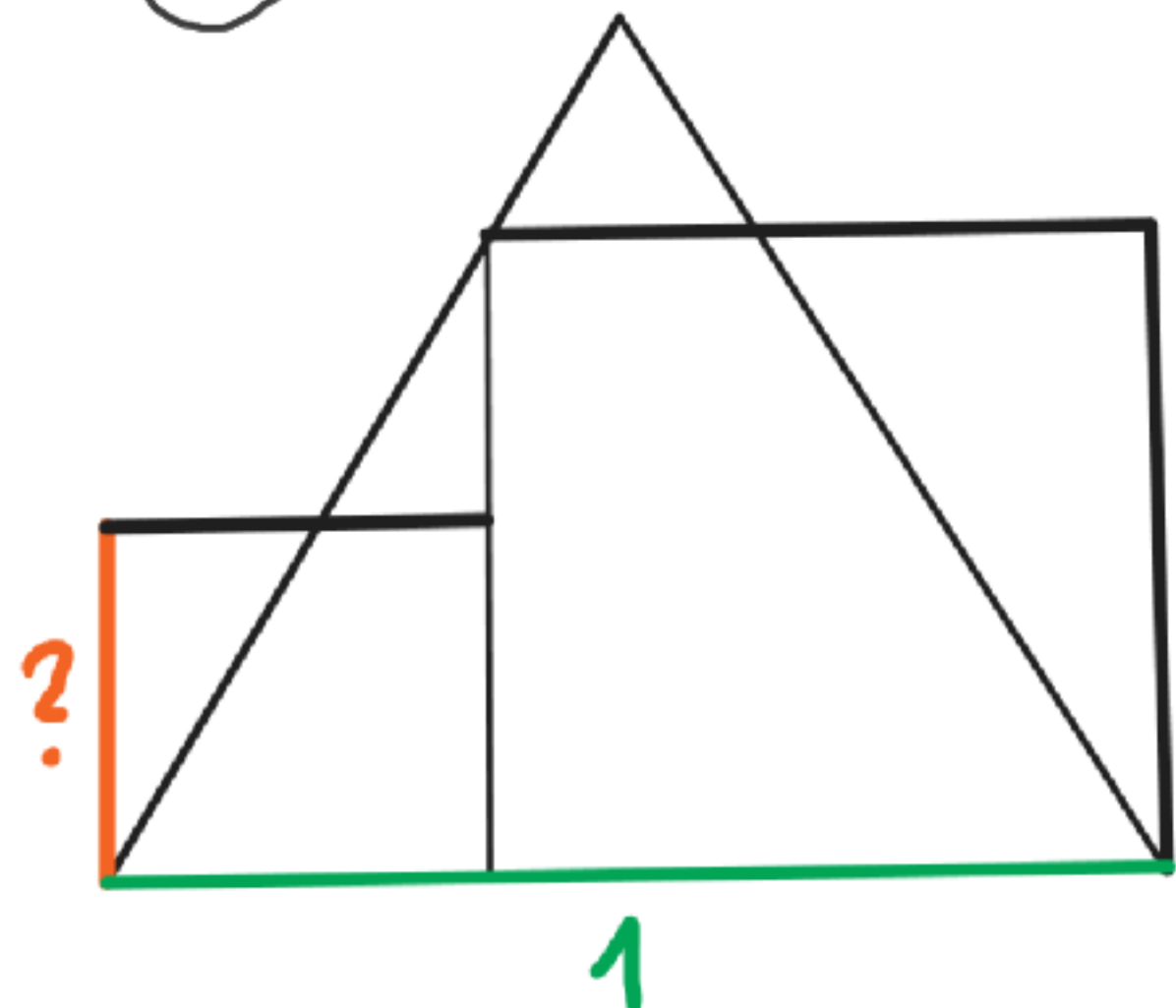

③

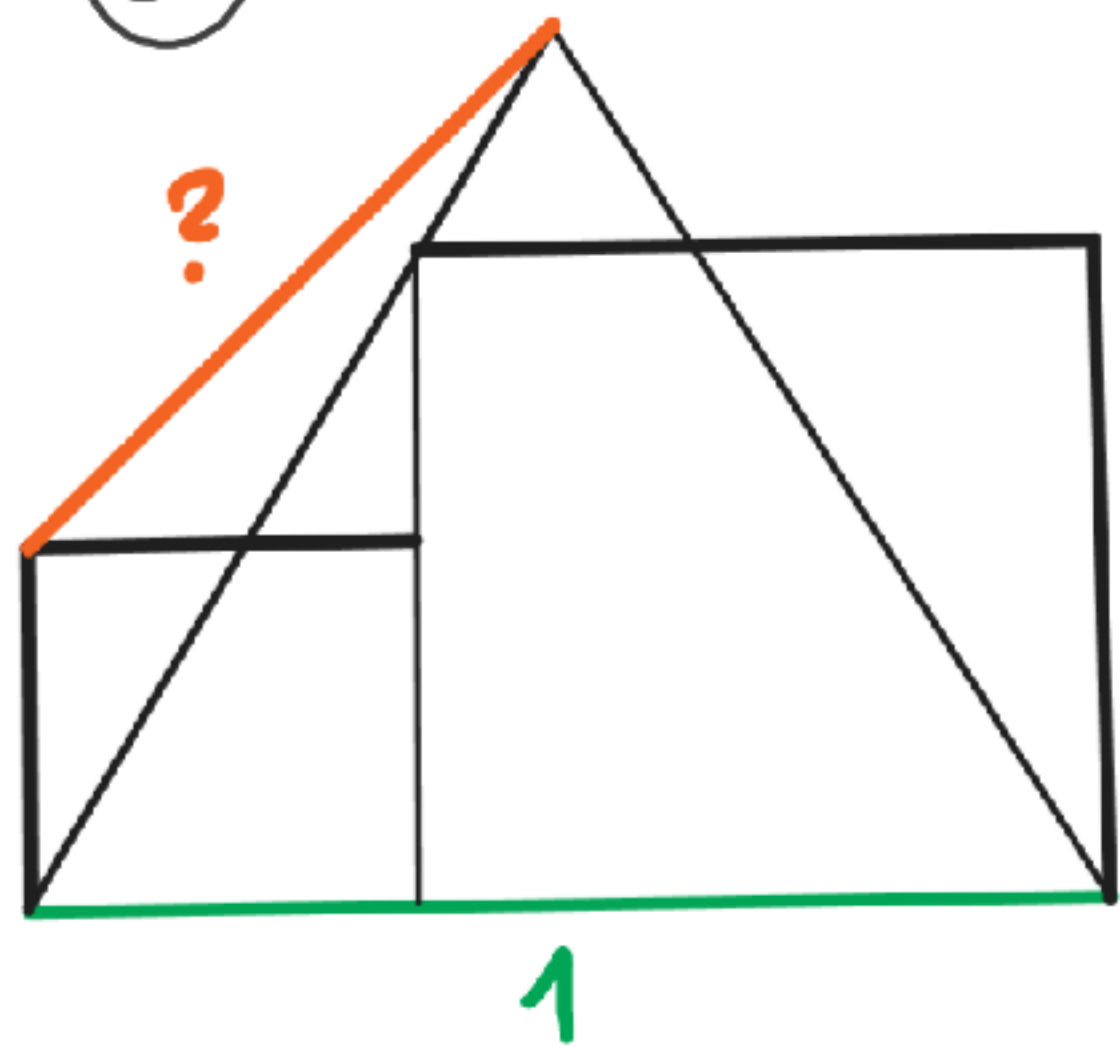

4

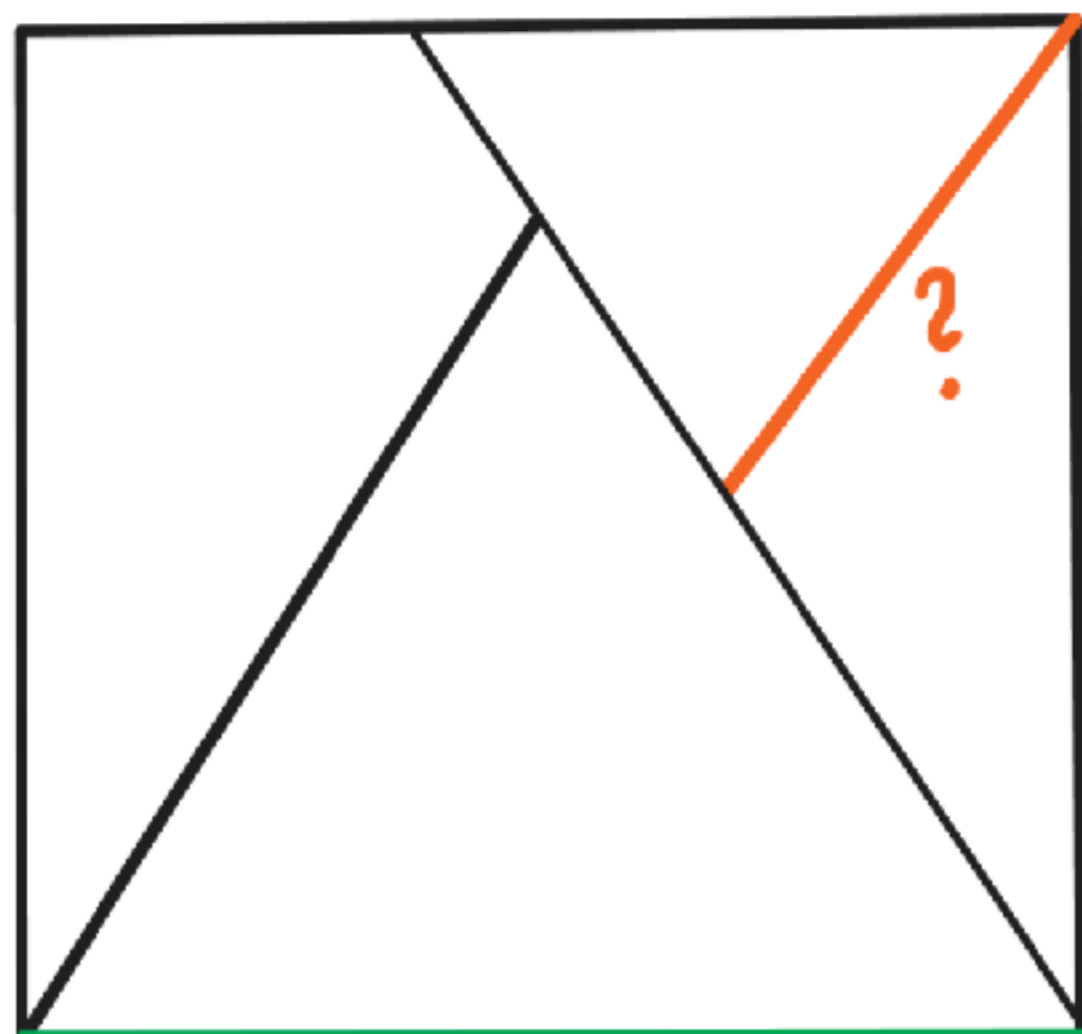

2

5

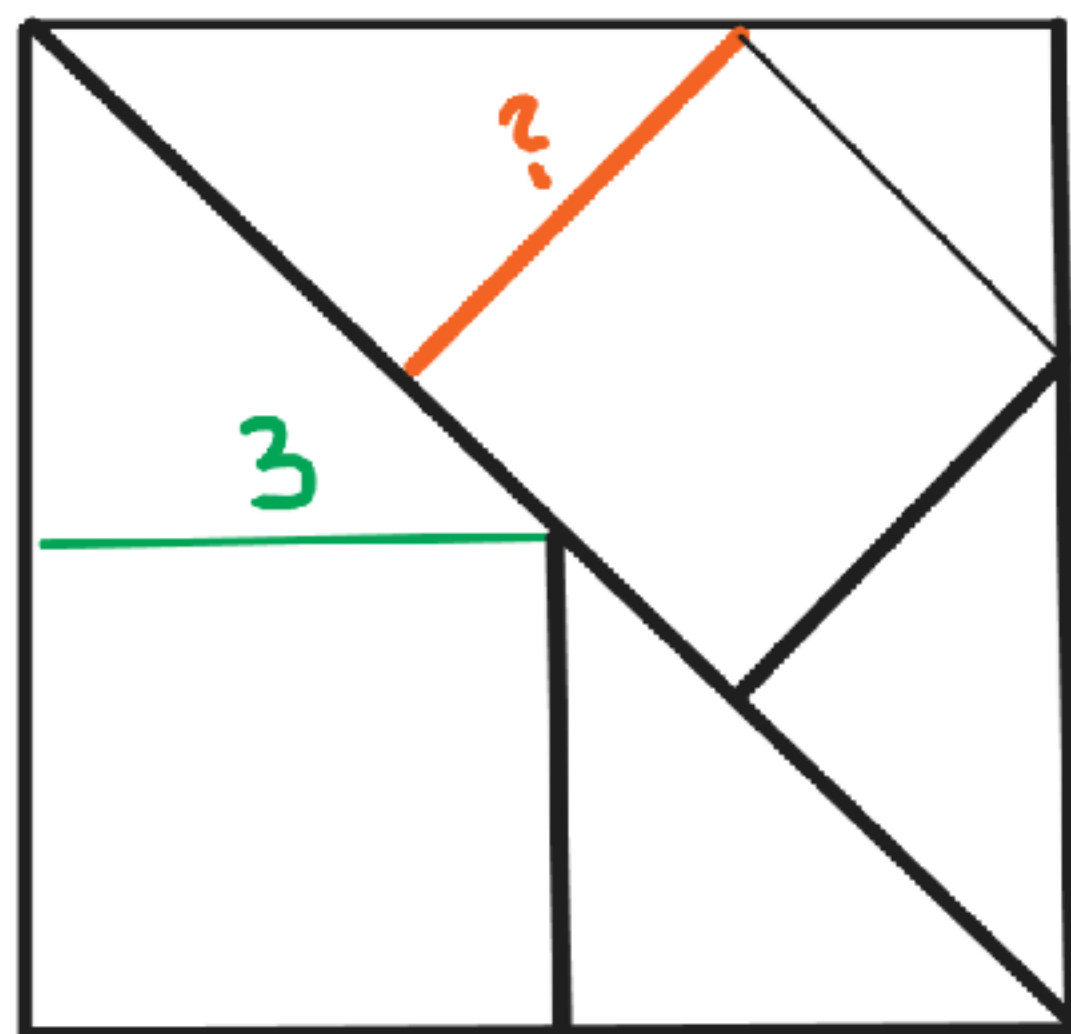

6

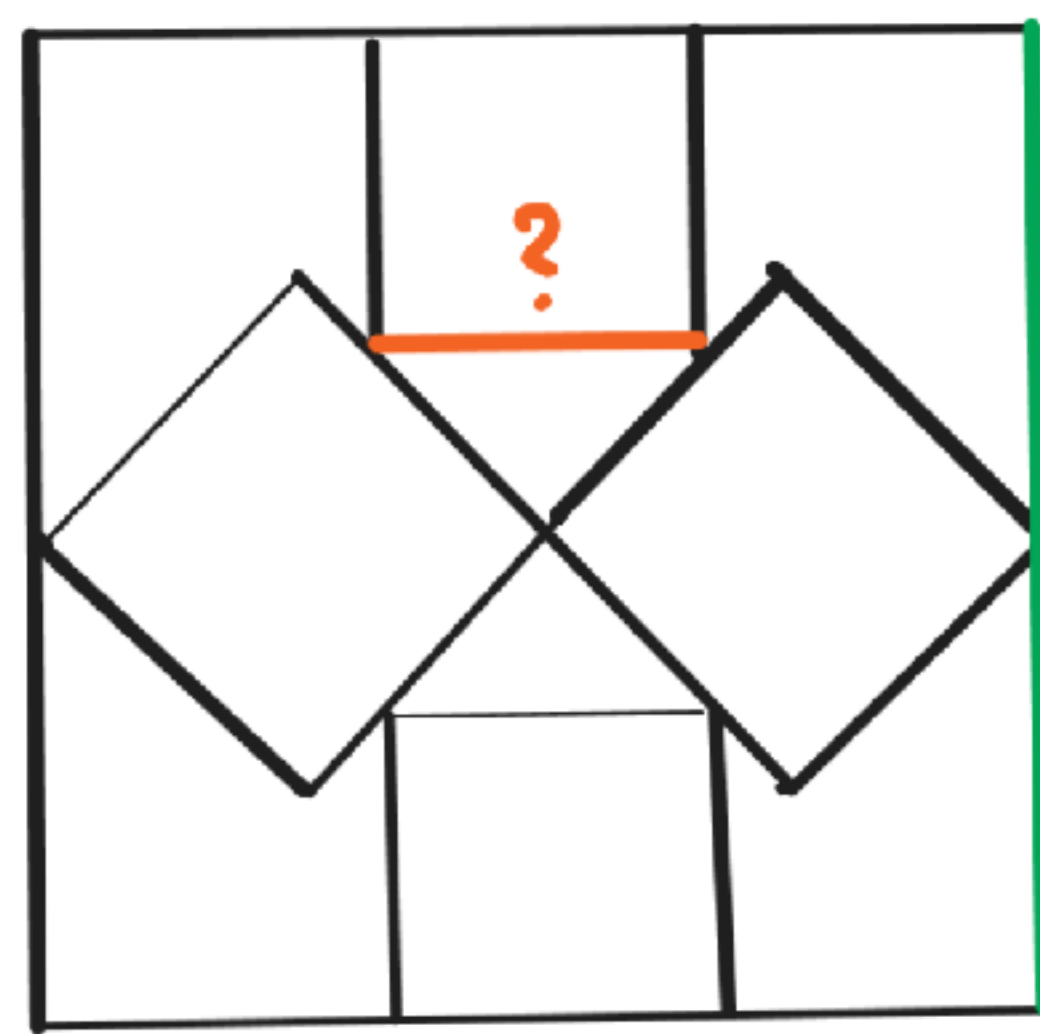

6

7

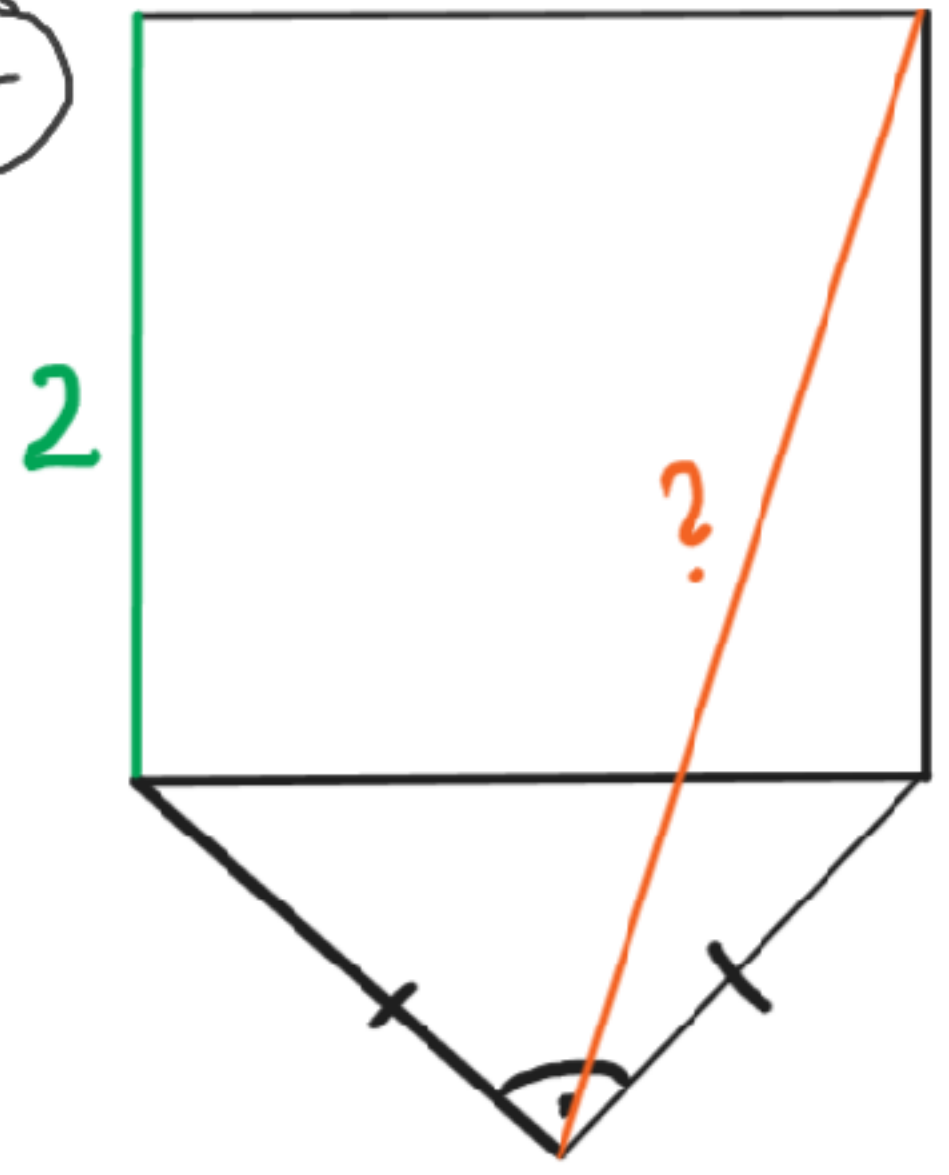

8

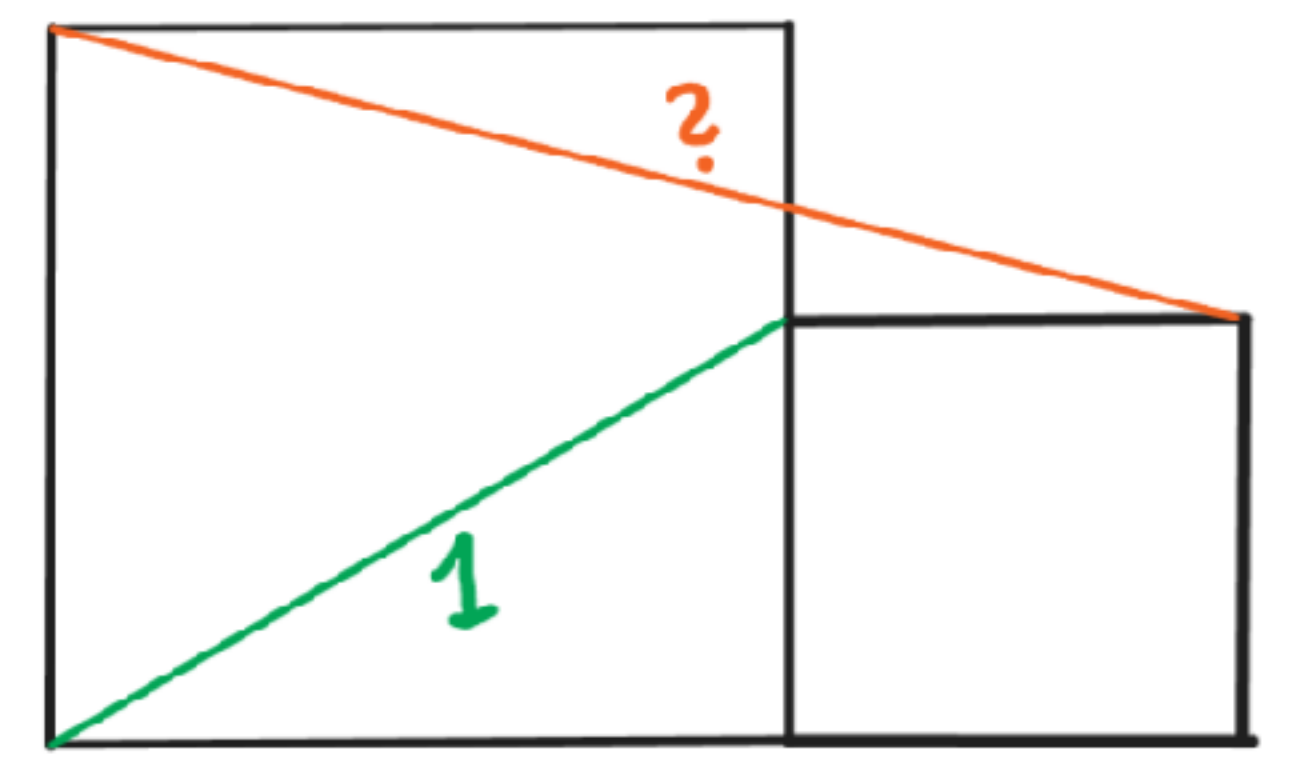

9

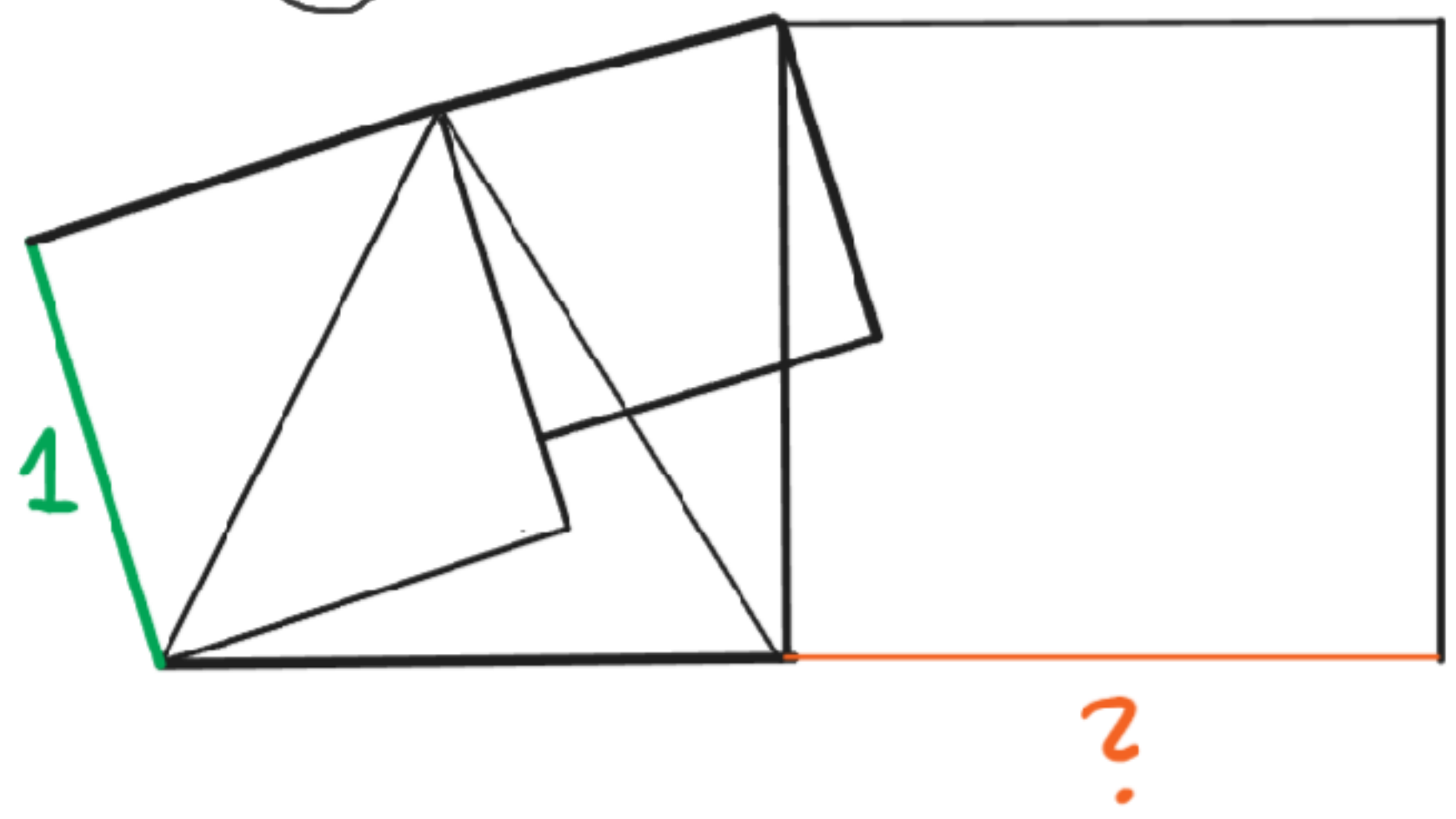

10

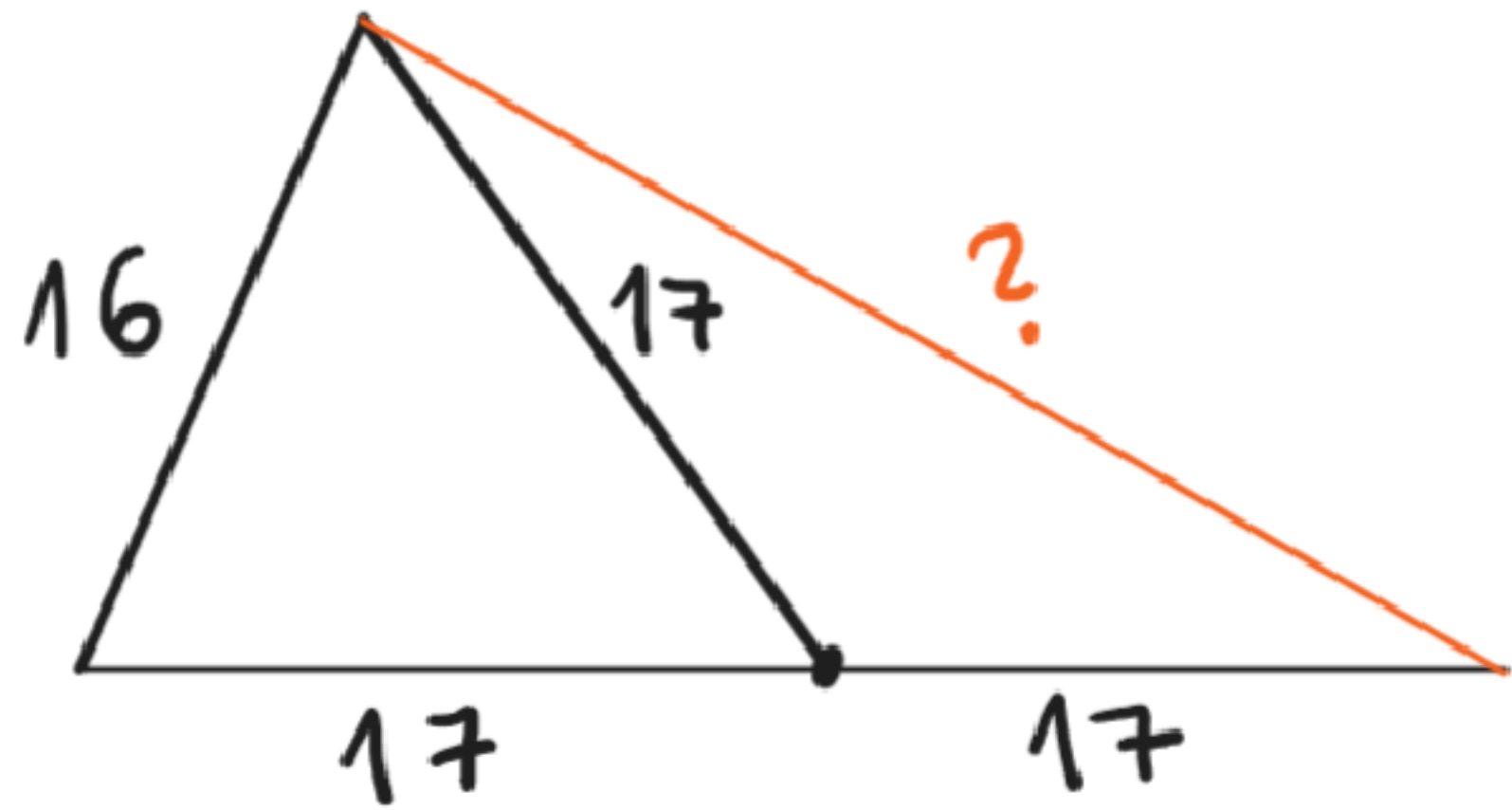

11

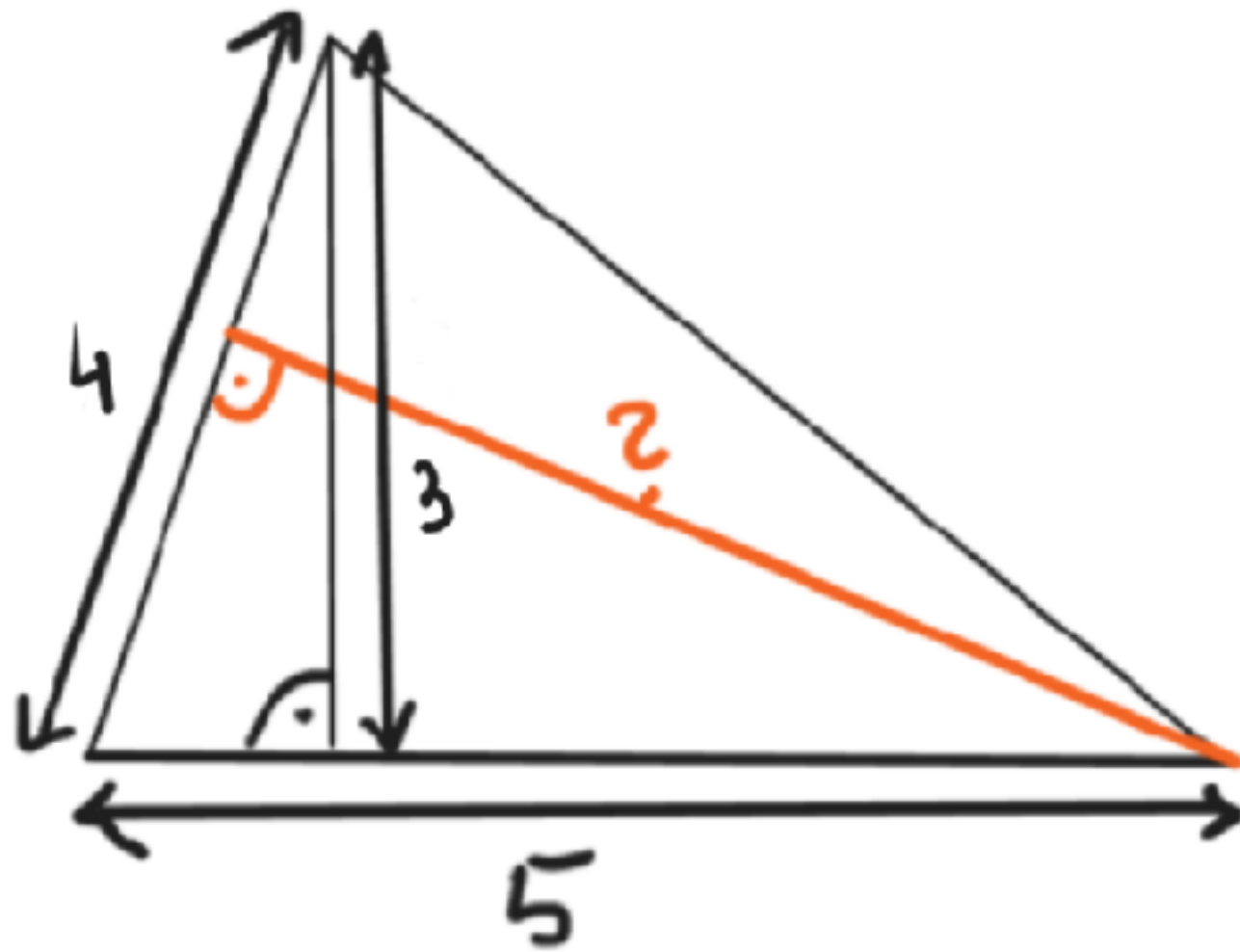

12

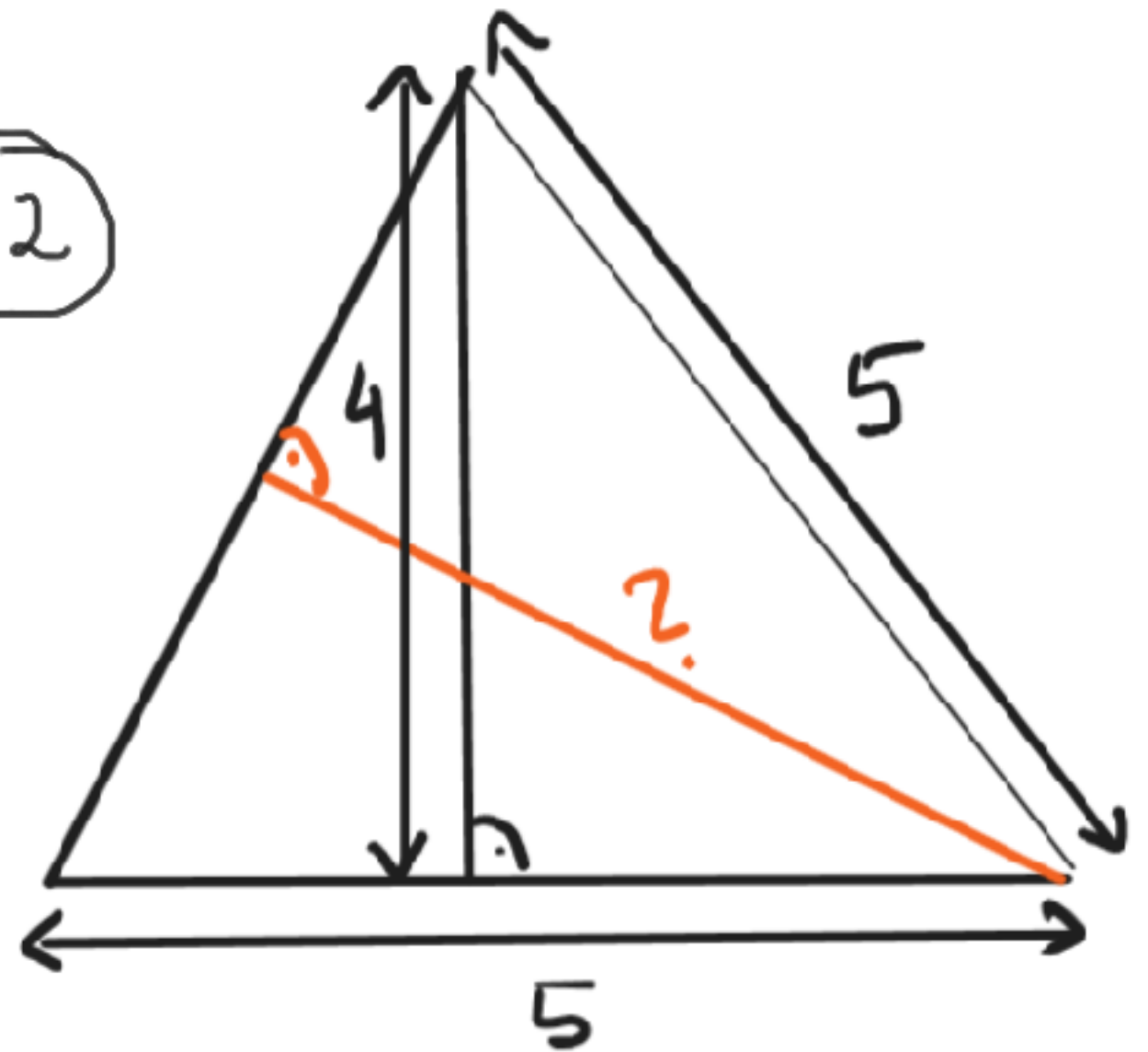

13

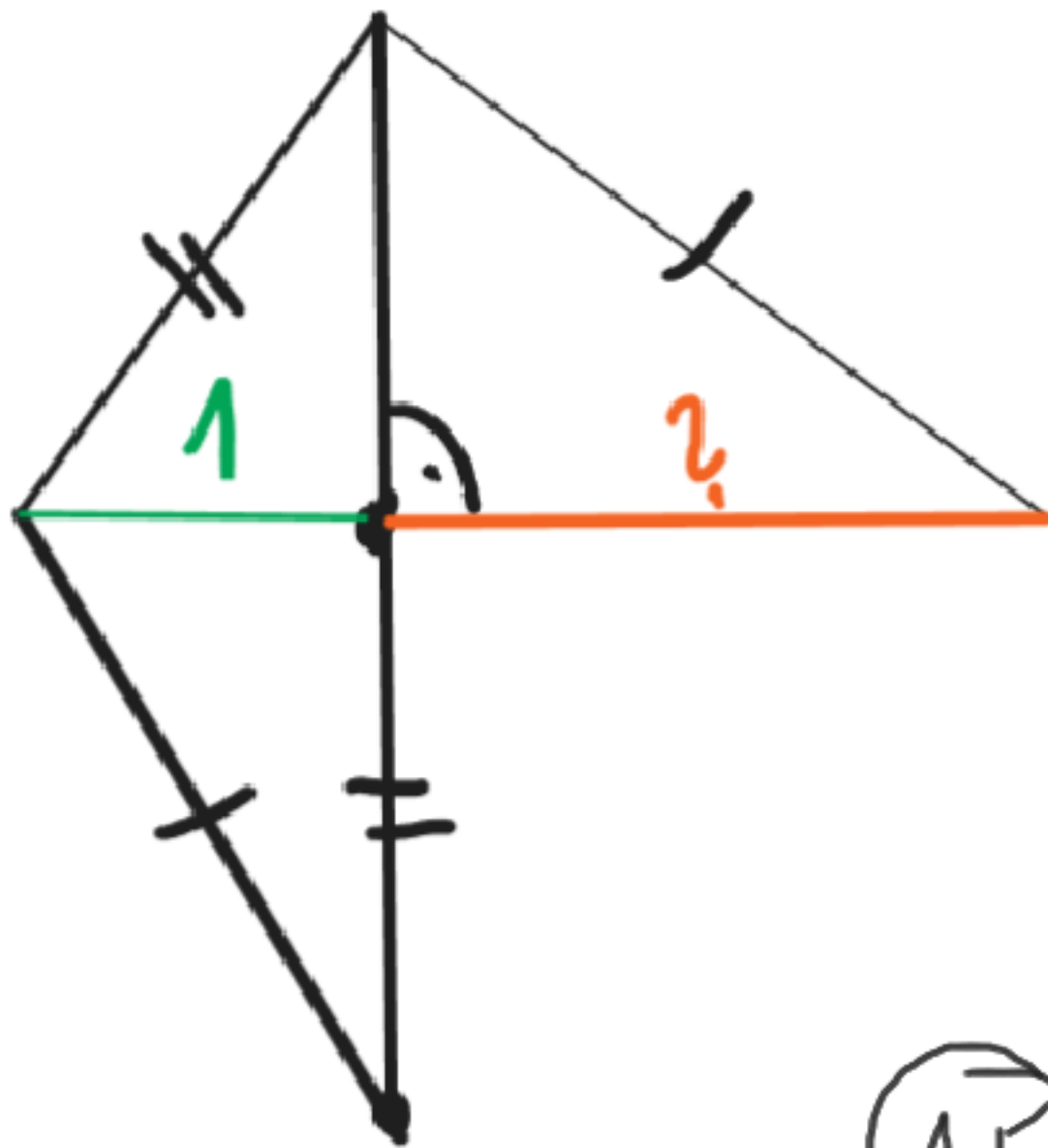

14

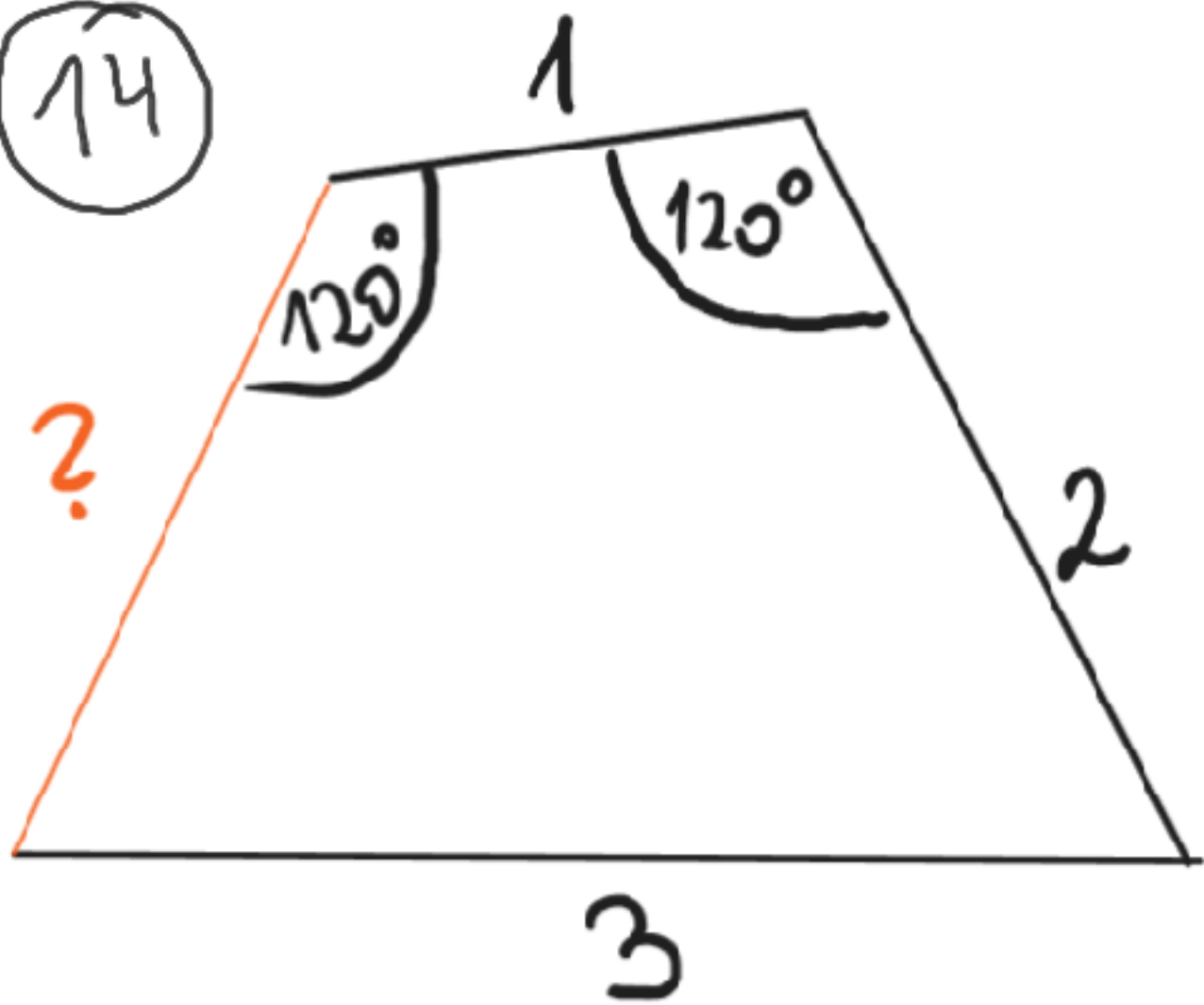

15

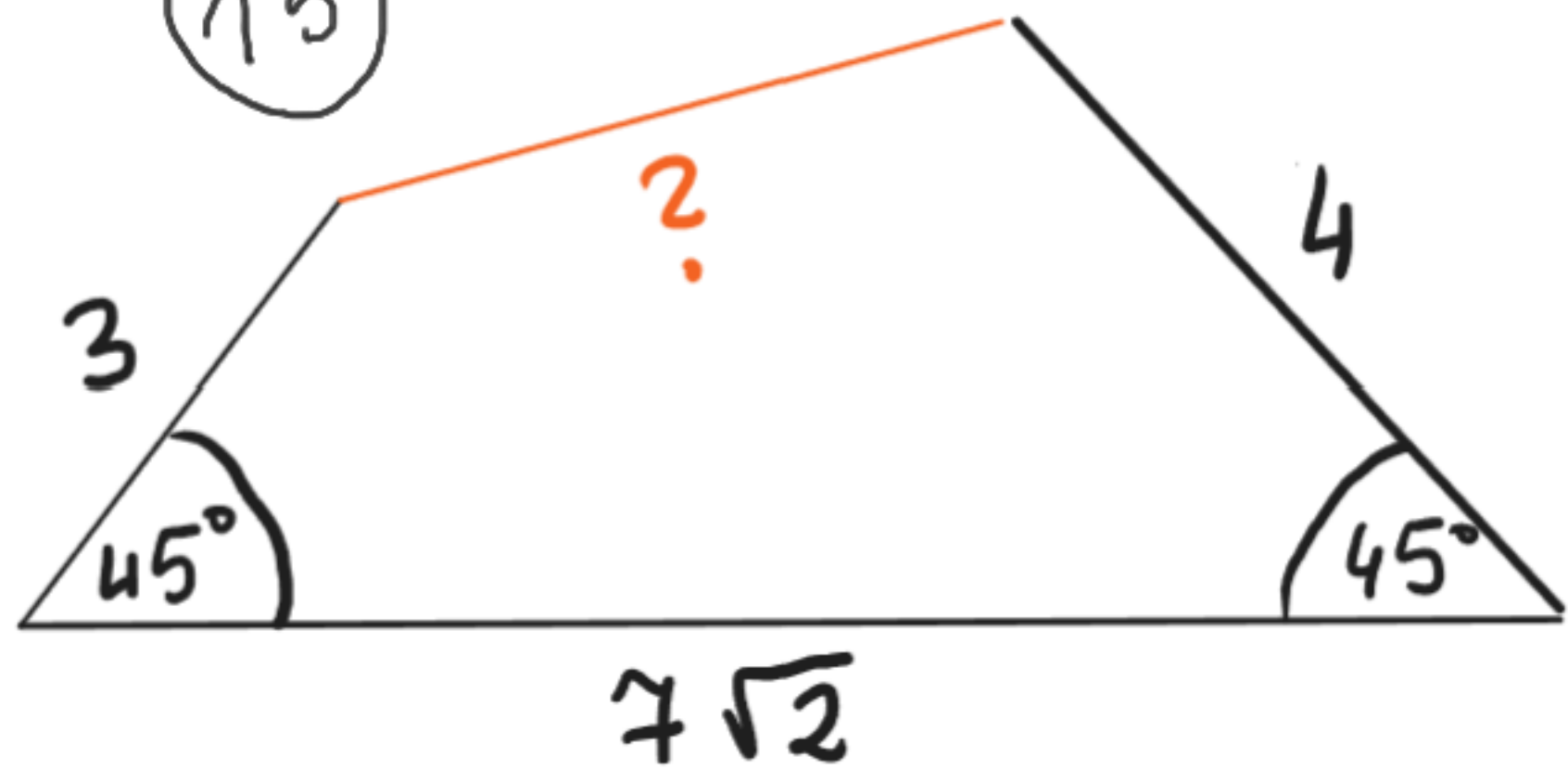



16

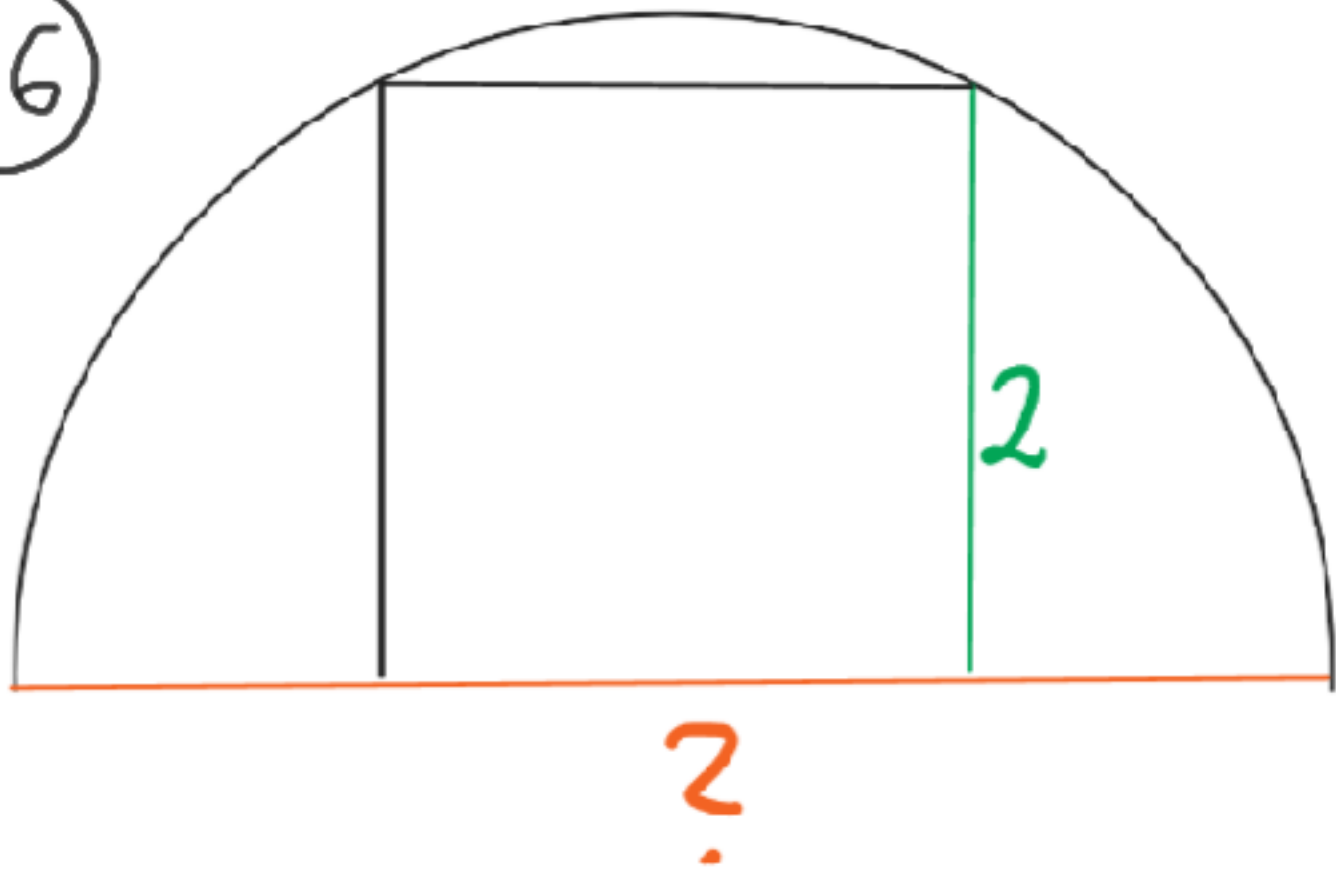

17

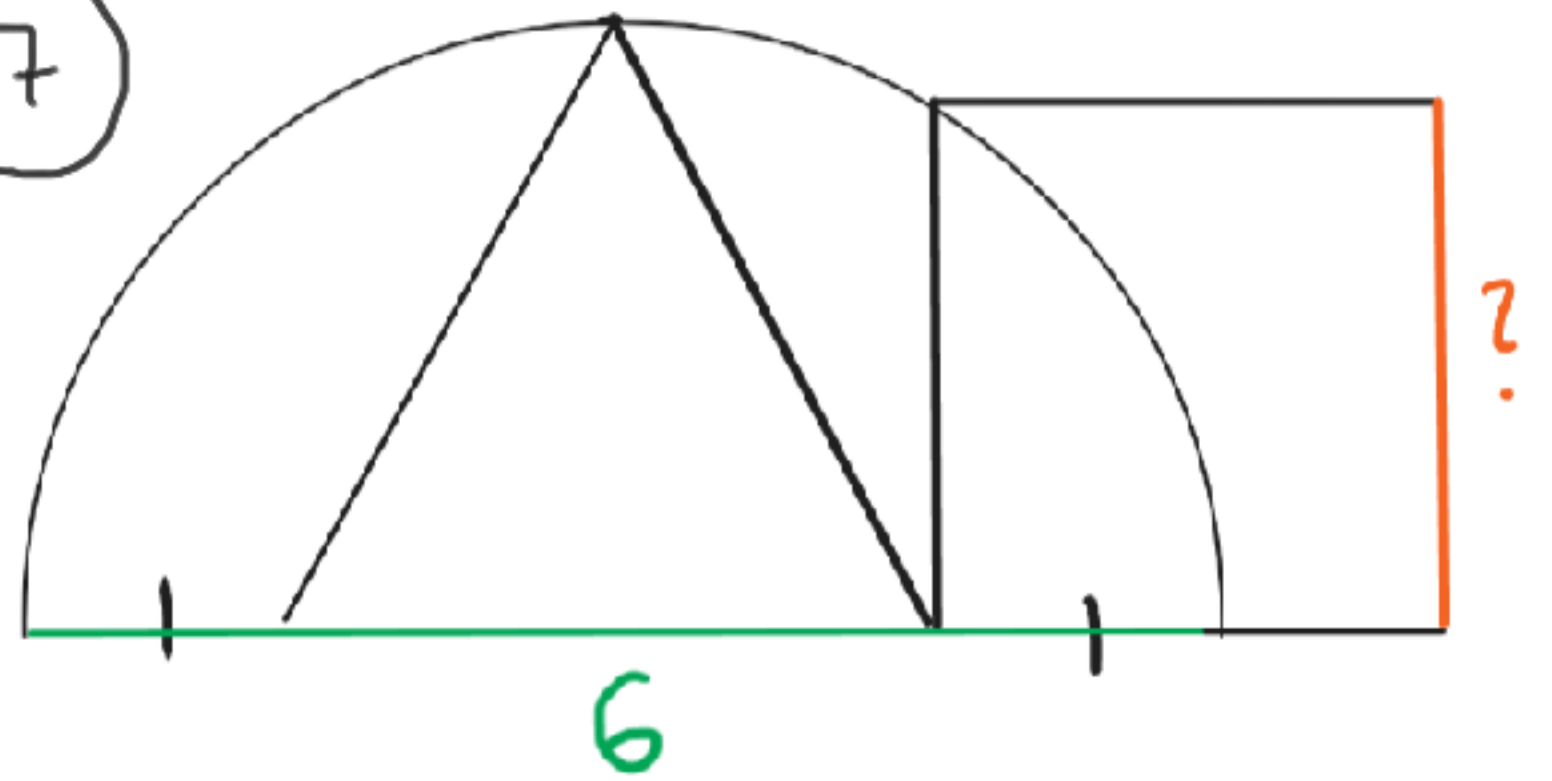

18

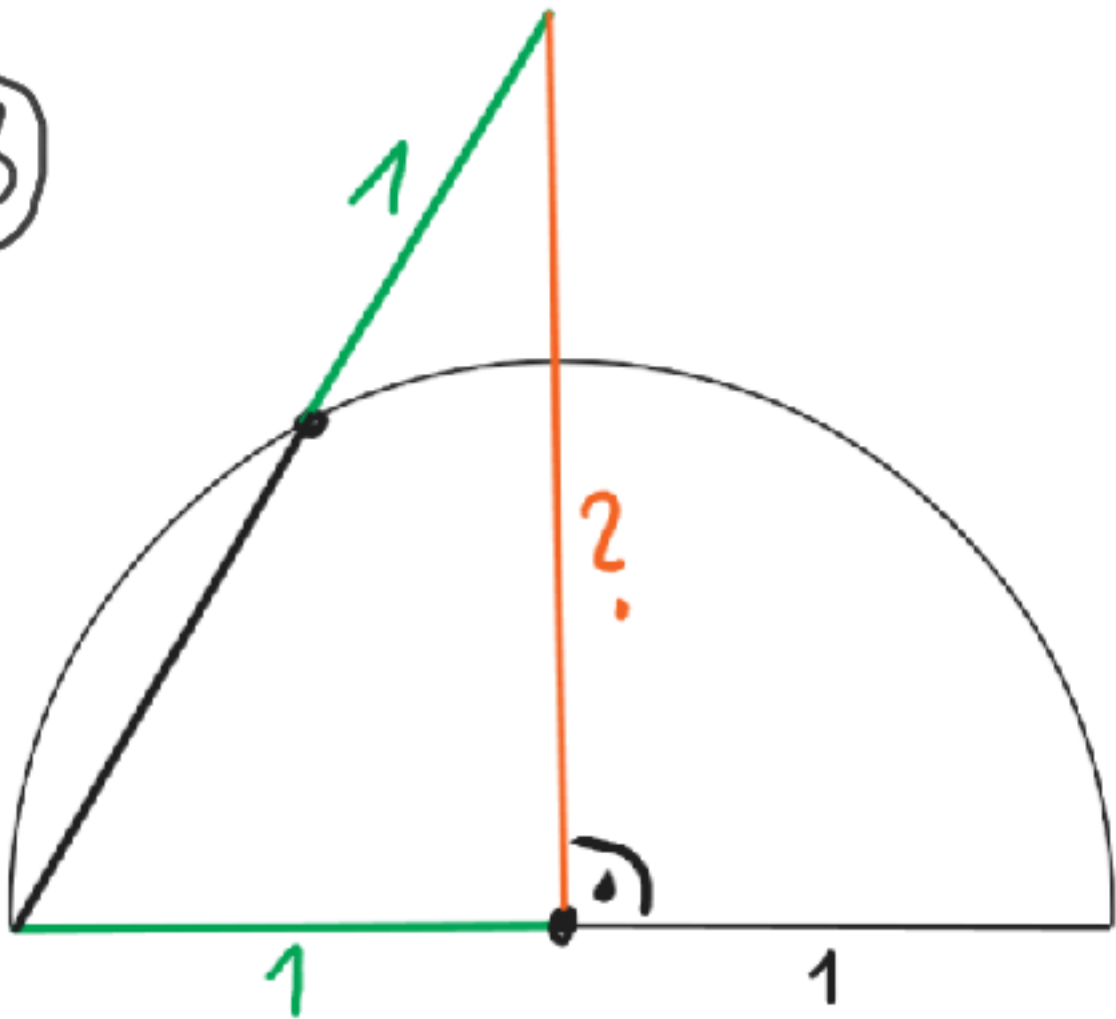

19

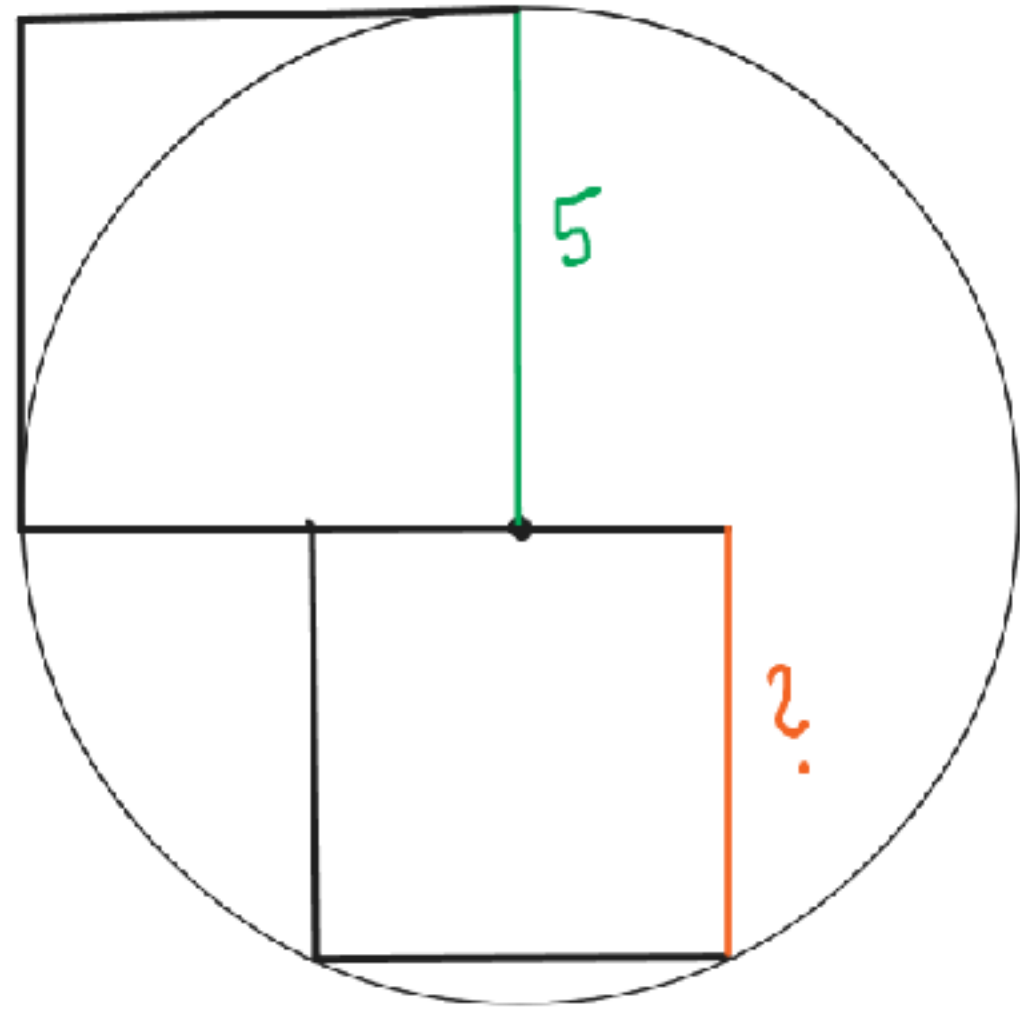

## Žródła / inspiracje do zadań

- ① Náboj 2019, zad. 19.
- ②, ③ Catriona Agg (Twitter), 14.03.2020.
- ④ Catriona Agg (Twitter), 12.11.2020.
- ⑤ Náboj 2019, zad. 9.
- ⑥ Catriona Agg (Twitter), 09.09.2018.
- ⑦ Náboj 2012, zad. 6.
- ⑧ Materiały Jerzego Bednarczaka.
- ⑨ Catriona Agg (Twitter), 26.12.2019.
- ⑩ I OMG, I stopnie, zad. 7.
- ⑪, ⑫ XVI OMG, I stopnie, zad. 2.
- ⑬ XVII OMG, II stopnie, zad. 1.
- ⑭ XVI OMG, I stopnie, zad. 4.
- ⑮ XIV OMG, I stopnie, zad. 2.
- ⑯ Catriona Agg (Twitter), 08.11.2018.
- ⑰ Catriona Agg (Twitter), 11.02.2019.
- ⑱ Náboj 2011, zad. 26.
- ⑲ Náboj 2018, zad. 11.